

User Instructions For PDT3P

Contents

Contents

- [User Instructions For PDT3P](#)
 - [Contents](#)
 - [PDT3P Version](#)
 - [Introduction](#)
 - [Installing the software](#)
 - [Connecting the PDT/PDR/PSR](#)
 - [Required Items:](#)
 - [The Main PDT3P Window](#)
 - [Title Bar](#)
 - [Upload To Pager Button](#)
 - [Download From Pager Button](#)
 - [Check Pager Version Button](#)
 - [The Set Time & Upload Button \(PDR Templates Only\)](#)
 - [Menu Options](#)
 - [File - New Open, Save, Save As](#)
 - [File - Set Template](#)
 - [File - Set Template Set ID](#)
 - [File - Comport](#)
 - [File - Program Mode](#)
 - [File - Import Capcodes](#)
 - [File - Exit](#)
 - [ES - Read, Write](#)
 - [ES - Upgrade](#)
 - [ES - Set password](#)
 - [ES - Set Time & Write](#)
 - [ES - Upload a specific SES file](#)
 - [ES - Get OTAP Capcodes](#)
 - [The Capcodes Window](#)
 - [Adding Capcodes \(Addresses\)](#)
 - [Output Options](#)
 - [Serial 1](#)
 - [Serial 2 \(PDT/PDR Only\)](#)
 - [Print](#)
 - [Maildrop](#)
 - [Type](#)
 - [Level](#)
 - [Relays 1-4](#)
 - [Global Option Clear By Keys](#)
 - [Output to Transmitter](#)
 - [Output to Control Relay Board](#)
 - [Capcode Control Relay Board Settings Window](#)
 - [Capcode Alarm Options](#)
 - [Capcode Alarm Settings Window](#)
 - [The Printer Options Window](#)
 - [Output Options](#)
 - [Output to Printer](#)
 - [Output Time & Date](#)
 - [Output Capcode](#)
 - [Output Form Feed](#)
 - [Put Header on Separate Line](#)
 - [Printer Page Width](#)
 - [Output Lines Between Messages](#)
 - [Printer Type](#)
 - [Number of copies to print](#)

- [Printer](#)
 - [The Serial Options Window](#)
 - [Serial](#)
 - [Serial Format](#)
 - [Header String](#)
 - [Footer String](#)
 - [Transmitter](#)
 - [Type](#)
 - [Retransmit all capcodes](#)
 - [Invert Transmitting Data](#)
 - [Stop receiving during retransmitting](#)
 - [Delay receiving](#)
 - [Key up Delay](#)
 - [Transmit Input Response](#)
 - [Output Response on Serial](#)
 - [Setup Response Messages](#)
 - [Response Input Options Window](#)
 - [Search messages from the receiver and output to TTS:](#)
 - [Response Serial Input Options:](#)
 - [Response for Logical Level Input Options:](#)
 - [Message Relay Options Window](#)
 - [Adding Text to Control Relays](#)
 - [Control Relay Options](#)
 - [Relays 1-4](#)
 - [Global Option Clear By Keys](#)
 - [Only match at beginning](#)
 - [Output to Control Relay Board Options](#)
 - [Message Control Relay Board Options Window](#)
 - [The Alert Options Window \(PDR/PSR Only\)](#)
 - [The Frequency & Notes Window](#)
 - [Frequency](#)
 - [Invert Decoder Bit Steam](#)
 - [Set Decoder Baud Rate \(POCSAG ONLY\)](#)
 - [Flex Network Options \(Flex ONLY\)](#)
 - [Receiver type](#)
 - [Allow decoding errors](#)
 - [Format Output](#)
 - [Remove leading characters](#)
 - [LCD contrast base](#)
 - [Remove duplicated messages](#)
 - [Notes](#)
 - [OTAP Options Window](#)
 - [Enable Over The Air Programming Capcode Option](#)
 - [OTAP Pager ID](#)
 - [Capcodes Levels](#)
 - [The PDT UI Settings Window](#)
 - [Use the following settings](#)
 - [Settings](#)
- [PDT3000 Peripherals](#)
 - [Port Pin-out](#)
 - [Serial Port2 to PC Cable](#)
 - [Salcom 11-72](#)
 - [Salcom 11-62](#)
 - [Tait T800](#)
 - [Maxon SD-125](#)
 - [Apollo TX-125](#)
 - [TXF-2000U](#)
 - [PSR3000 with Transmitters](#)
 - [Alarm Inputs](#)
 - [PDT/PDR/PSR ROM Limitation](#)

PDT3P version 6.0 or over can only be used for PDT3000/PDR3000/PSR3000 with the M16/62PE(M30626FHPFP) type of the processor and does not support the M16/62P(M30624FGFPF) and M16/62A(M30624FGAFP) processor type.

If PDT/PDR/PSR has M16/62PE(M30626FHPFP) processor type on board but with an old version firmware, the steps below must be followed to upgrade:

1. "Download from pager" to read the pager configure first.
2. "Upload to pager" to write the pager configure into the new ROM area for version 6.0 or over ROM.
3. "Upgrade" the "pdt_flash_PEV6.0.rom" to PDT/PDR or the "psr_flash_PEV6.0.rom" to PSR from the "ES | Upgrade | flash" folder.
4. Then "Upgrade" the "pdtVx.x.rom" to PDT or the "pdrVx.x.rom" to PDR or "psrVx.x.rom" to PSR from the "ES | Upgrade" menu.

Introduction

Paging Data Terminal 3000 Programming (PDT3P) software is used to set up configurations for Paging Data Terminal 3000 (PDT3000), Paging Data Receiver (PDR3000) and Paging Serial Receiver 3000 (PSR3000).

There are 3 components to programming a PDT/PDR/PSR; this software (PDT3P), the templates that are loaded by PDT3P when it is first started and the firmware contained in the product.

It is very important to understand the difference between these three components.

Templates determine the type of product and model of product that is to be programmed. When PDT3P is first loaded onto a PC a template ID key is requested. This key determines which templates will be visible. There are about 30 templates however you will only receive a key for the templates that you require. When PDT3P is started subsequently a template window will pop up to allow you to select the correct template. If the key you were originally provided was for a single template then this window will not appear and PDT3P will automatically load that template. Additional templates can be activated by changing the template ID key. Note that it is possible to program a unit with an incorrect template and this will cause the product to act in an incorrect manner. This will not, however, damage the unit. The current template loaded will always appear in the title bar at the top of PDT3P. When a download from a unit is carried out, PDT3P will automatically load the current template contained in that unit.

PDT3P is used to set the programmable configuration parameters of the unit such as frequency, cap codes, I/O settings etc. The user interface and the functions visible in PDT3P will change according to which template is loaded.

The firmware contained in the PDT/PDR/PSR determines its basic operational capabilities. There is only one version of firmware (rom file) available for each of three different types of product. All other differences between different models of the same product are set using the templates.

Installing the software

PDT3P requires a PC running Windows 2000/NT/XP and at least 32MB RAM.

1. Run the installer by double clicking on PDT3Px.xx.exe.
2. Follow the instructions in the installer wizard.
3. Once installed run PDT3P by clicking on the shortcut in the Start menu or selecting PDT3P.exe from the folder in which it is installed.
4. You will be prompted to Enter Set ID . The key will have been provided to you or may be contained on the CD in a notepad file called PDT3P Key.txt.
5. Hit OK.
6. If your key permits access to more than one Template then a selection of templates will appear in a new window. If your key only allows access to one template then PDT3P will start automatically in that template.

Connecting the PDT/PDR/PSR

Required Items:

- 1 x Serial Null Modem DB9 female-to-female cable.

- 1 x 12v DC Power supply rated at 0.5 amps (or greater) with 2.5mm center positive plug attached.

1. Plug the serial cable into the PC (COM1 is the default port)
2. Open PDT3P
3. Select the template appropriate to the PDT/PDR/PSR that you are programming. Note: if you only have a key for one template then PDT3P will open automatically with that template active.

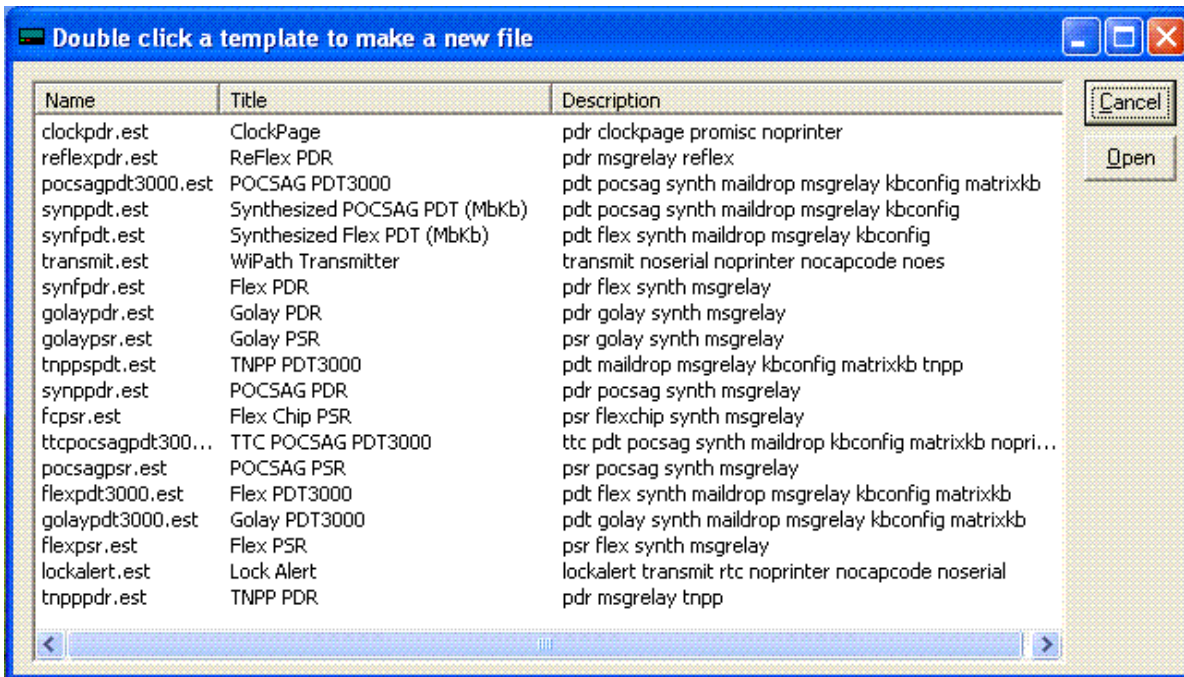

4. Plug the PDT/PDR/PSR into a 12-volt supply and plug in the DB9 plug into the back of the PDT/PDR/PSR.

{PDT3P does not read or write to the PDT/PDR/PSR unless instructed to do so. It is recommended that unless you need to change the basic template of the PDT/PDR/PSR then you download the programme in the unit first. Click on the "Download From Pager" button. This will download the current settings from the PDT/PDR/PSR. It will also automatically select the template that is currently loaded in the PDT/PDR/PSR. If you need to change the basic template of the PDT/PDR/PSR do not do a download. Just select your template, change the settings and press "Upload To Pager" (Please consult) }

[The Main PDT3P Window](#)



Title Bar

The blue Title Bar at the top shows the current Template selected.

Upload To Pager Button

This button is used to upload new settings to the PDT/PDR/PSR. This will overwrite any settings currently in the PDT/PDR/PSR.

Download From Pager Button

This button is used to download the current settings from the PDT/PDR/PSR. This will overwrite any settings currently in PDT3P and will change the template in PDT3P to that programmed in the PDT/PDR/PSR if different from that showing.

Check Pager Version Button

This button is used to read the software and hardware versions from the PDT/PDR/PSR.

The Set Time & Upload Button (PDR Templates Only)

This button is used to set the time and upload the new settings to the PDR2000. Time is set on the PDT in the PDT User Interface or by selecting the set time and write function in the ES menu.

Menu Options

File - New Open, Save, Save As

Open, save or create new configuration files which are saved as .ses files.

File - Set Template

Change the current template. (This option is only available if you are authorized for more than 1 template option.)

File - Set Template Set ID

Change the key that authorizes the templates available. (This option is only available if you are authorized for more than 1 template option.)

File - Comport

Change the comport to which the PDT/PDR/PSR is connected.

File - Program Mode

Local ---- Program a unit which is directly connected to a PC serial port

Remote -- Program a unit when it is connecting to a PC serial port through a virtual serial connection(for example: serial---ethernet---serial) and the unit must be setup to be controlled remotely first. Some functions like "Set time" and "Get OTAP Capcode" can not work in this mode.

File - Import Capcodes

Provides the capability to load a large number of cap codes from a .csv file. The csv file format should follow the sample files in PDT3P/data folder.

File - Exit

Finish the program and exit.

ES - Read, Write

Read and write configuration settings to and from the PDT/PDR/PSR. These are the same as the Upload and Download Buttons on the main screen (see below)

[ES - Upgrade](#)

Use this option to upgrade the Flash ROM in the PDT/PDR/PSR. Only use this option if instructed to do so by a service representative. The latest rom file will always have the same version number as the PDT3P version currently loaded.

[ES - Set password](#)

Set up a password to prevent an unauthorized person from reading or writing program from or into the PDT/PDR/PSR

[ES - Set Time & Write](#)

Set the time and write configuration settings to the PDT/PDR. This is the same as the Set Time and Upload button on the main screen (see below)

[ES - Upload a specific SES file](#)

Upload the configuration in the SES file to ES without changing anything in the file.

[ES - Get OTAP Capcodes](#)

Read Over The Air Programming Capcodes from the PDT/PDR/PSR. The OTAP capcodes which the unit had can be displayed on the OTAP option window if this reading operation was successful.

[The Capcodes Window](#)

This window is used to set the cap codes (addresses) and the output settings for each cap code.

The screenshot shows the 'Pager Cap Codes' window. It features a table on the left and several configuration panels on the right.

Capcode	Range	Name	Type	Serial2	Serial1
1	0	Network lost	Alpha	0	0
2	0	Network fo...	Alpha	0	0
1234567	10	Test CAP	Alpha	0	1
999132	0	Test Number	Alpha	0	1

Capcode and Options

Capcode: 1234567
Range: 10
Name: Test CAP

Output on Serial 1 Alpha Type
 Output on Serial 2
 Output on Printer Level: A B
 Output on Transmitter Maildrop C D

Global option: Clear by Keys

Relay	Action	Time(ms)	Delay(ms)	Global option:
1:	No Action	0	0	<input type="checkbox"/>
2:	No Action	0	0	<input type="checkbox"/>
3:	No Action	0	0	<input type="checkbox"/>
4:	No Action	0	0	<input type="checkbox"/>

Transmitter options

Capcode: 999132 Level: A

Output to control msg relay board options

RCM3000 27 Total of Relays Relay action

Capcode alarm options

Set capcode alarm Capcode alarm

[Adding Capcodes \(Addresses\)](#)

1. Enter a new CAP code by clicking on the "New" Button.
2. Enter the new CAP code in the "Capcode" box and the name in the name box below. i.e., 1234567 TEST CAP. The name is just an identifier and is not compulsory.
3. If a range of cap codes is required then select the first cap code and the range that you wish to monitor e.g entering cap code 1000000 and a range of 50 will monitor cap codes 1000000 to 1000050.
4. Set each of the desired outputs individually for each cap code by highlighting the cap code in the Left hand window and then selecting the outputs on the Right.

[Output Options](#)

[Serial 1](#)

The message received on this address/cap code will output on serial 1 - Set serial options (global) in the Serial Options window. For some serial formats, such as: "Control Input", "GPS Input", "IPage Input", "TNPP Output", "TNPP Input", "Output to Relay Board", "Message Direct to Relay Board" and "Message Manager", it is default to input or output all data through the serial and does not need to tick this option.

[Serial 2 \(PDT/PDR Only\)](#)

The message received on this address/cap code will output on serial 2 - Set serial options (global) in the Serial Options window. For some serial formats, such as: "Control Input", "GPS Input", "IPage Input", "TNPP Output", "TNPP Input", "Output to Relay Board", "Message Direct to Relay Board" and "Message Manager", it is default to input or output all data through the serial and does not need to tick this option.

[Print](#)

The message received on this address/cap code will be output on the Printer port (parallel printer) or Serial 1 (serial printers). Set printer options (global) in the Printer Options window.

[Maildrop](#)

Sets this address as a maildrop capcode. Messages will be stored and overwritten automatically in the Maildrop area of the display and will not be stored in the normal messages area.

[Type](#)

This option allows the type of message received to be set. In Flex Templates the options are Alpha, , Alpha Warning and Alpha Watch. In pocsag the tone and numeric options are added. Note: Alpha Warning and Alpha Watch are special settings that allow different initial alerts to be set for messages received on that capcode.

[Level](#)

Sets the pocsag levels for the capcode(ONLY in POCSAG Templates)

[Relays 1-4](#)

Sets the action that will occur on each of the 4 on board relays on receipt of any message on that capcode. Relays are Normally Open. Options are

1. Close Relay
2. Open Relay
3. Momentary Close Relay for a period (in msec)

[Global Option Clear By Keys](#)

If selected any relay action initiated on that selected relay, by any capcode, will be cancelled (reset to

normal condition) by hitting any key (PDT2000 only).

Output to Transmitter

When a transmitter is connected this sets the output capcode and pocsag level to which the message received on this address will be transmitted in pocsag.

Output to Control Relay Board

This sets the actions of any one or more of the relays contained on the RCM2000 module. Each RCM2000 adds 32 additional relays and may be daisy chained. (Note: This only works when one of the serial output format is selected as "Output to Relay Board").

Select the "Total of Relays" which are determined by the number of the chained RCM2000 modules.

Click the "Select relay action" Button to start up the Capcode Control Relay Board Settings Window.

Capcode Control Relay Board Settings Window

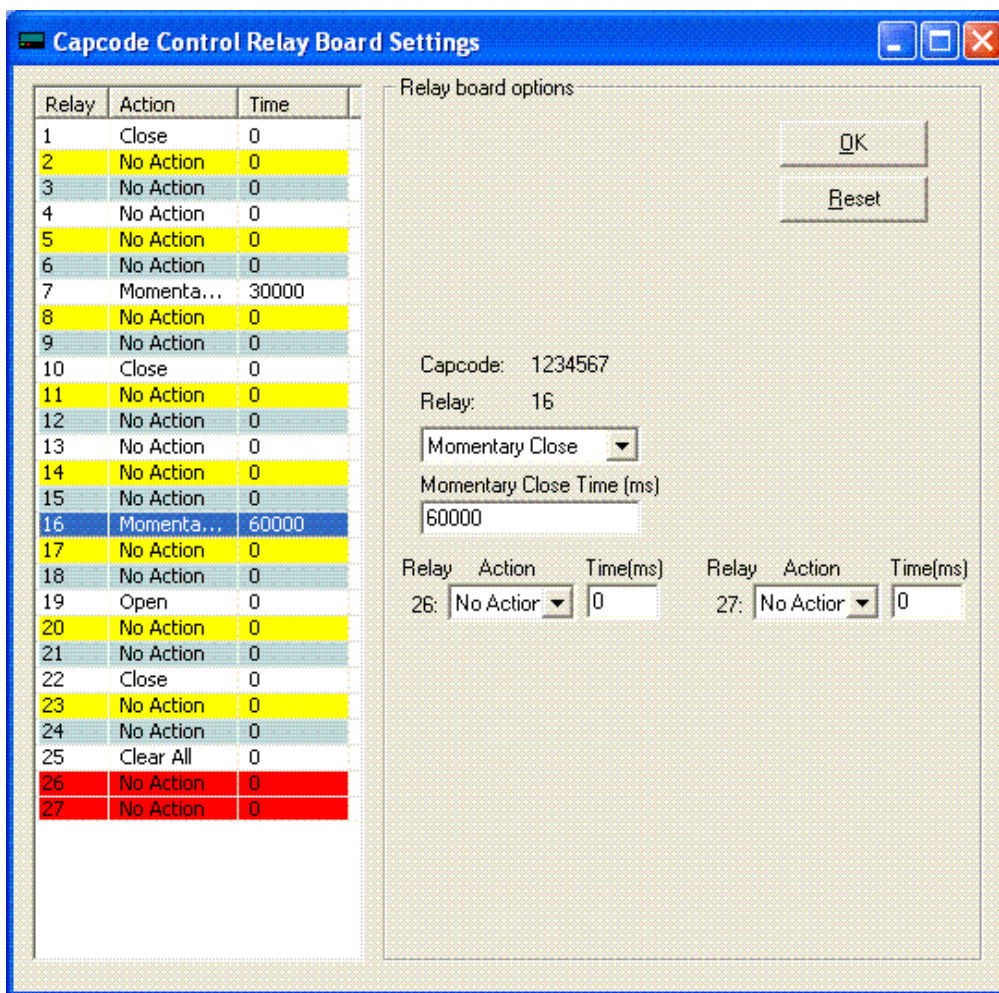

Click any number of relays at the relay list table in this Window, then select the action in the "Relay Action" and "Momentary Close Time" box. After finishing all settings, click the "OK" Button to save the settings and return to the last window.

Click the "Reset" button to clear the relay list table and give up the current settings.

Capcode Alarm Options

This sets the alarm actions of any capcode in the Capcodes Window. When a capcode is not received within a certain time period, it will trigger an alarm which can be the relays or the buzzer.

Capcode Alarm Settings Window

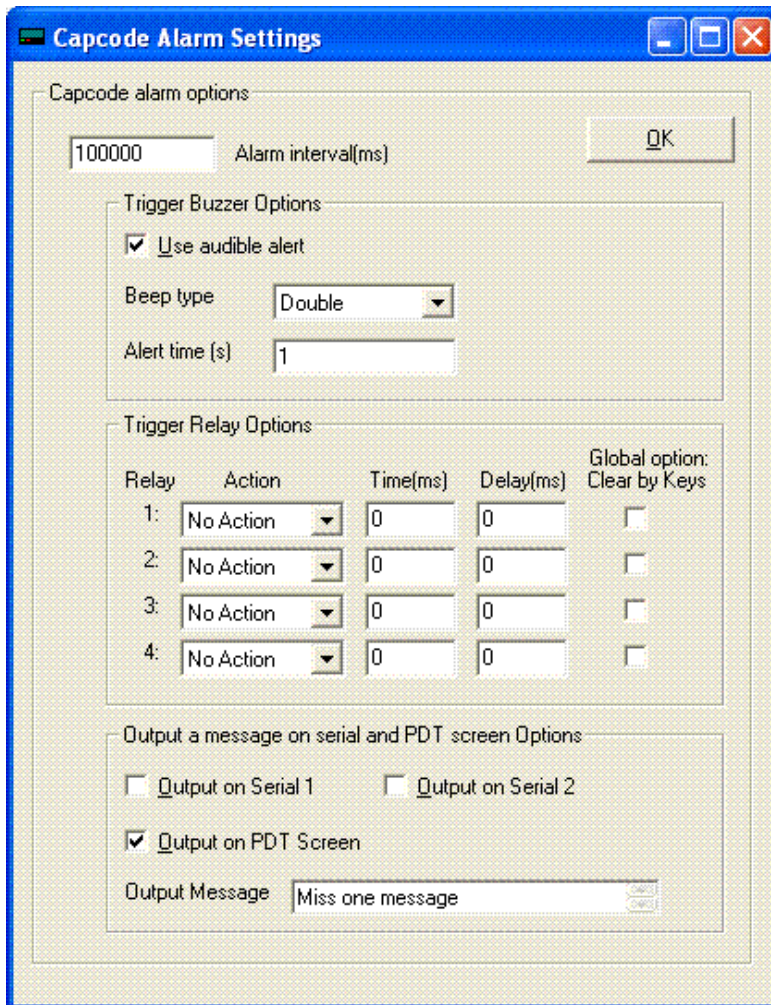

Input a certain time period in the "Alarm goes off time(ms)" text-box. After this period time(ms), if the unit does not receive the capcode, it will trigger alarms.

Click the "Use audible alert" check-box, the unit will trigger the buzzer alarm.

Sets the action that will occur on each of the 4 on board relays when any message on that capcode is not received within above setting time.

Tick the "Output on serial 1" or the "Output on serial 2" or the "Output on PDT screen"(PDT ONLY) when any message on that capcode is not received with above setting time.

[The Printer Options Window](#)

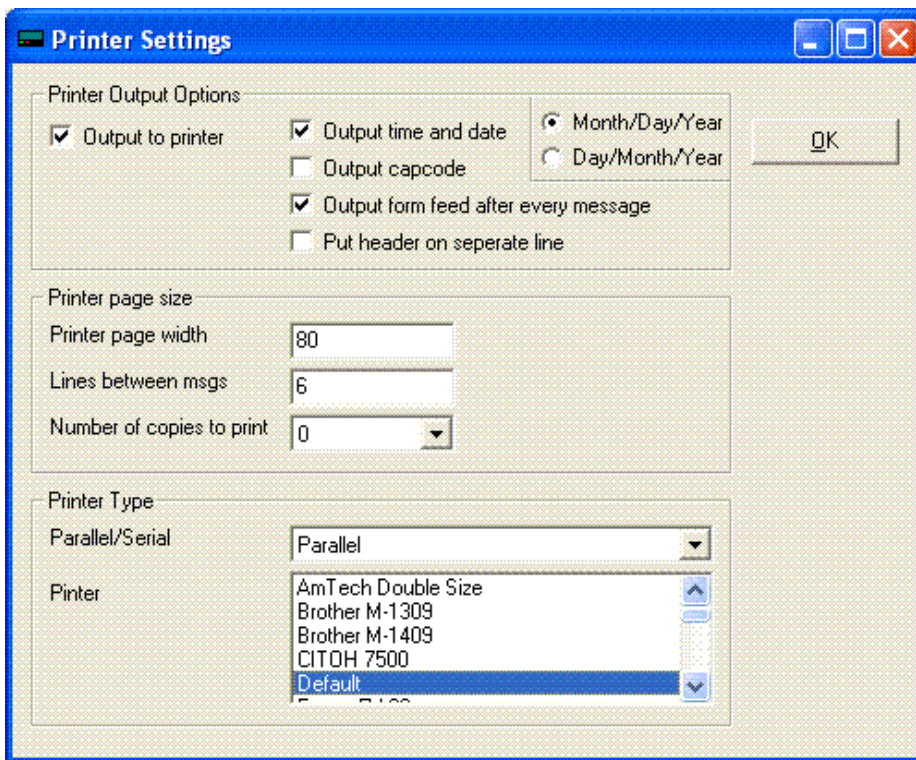

Output Options

Output to Printer

Turns printing on (global option). Note: printing still needs to be set for each individual capcode in the Capcodes window.

Output Time & Date

Outputs Time & Date to Printer.

Output Capcode

Outputs Capcode to Printer.

Output Form Feed

Outputs a Form Feed to Printer.

Put Header on Separate Line

Puts the Header (Date/Time, Capcode) on the first line followed by the message after a line feed.

Printer Page Width

Set the width of the paper. It may refer number of characters per line if a printer is set up as double size font.

Output Lines Between Messages

Outputs a selectable number of line feeds following each message.

Printer Type

Set printer type as parallel or serial.

Number of copies to print

Output a number of copies to printer

Printer

Contains a number of common printer drivers.

The Serial Options Window

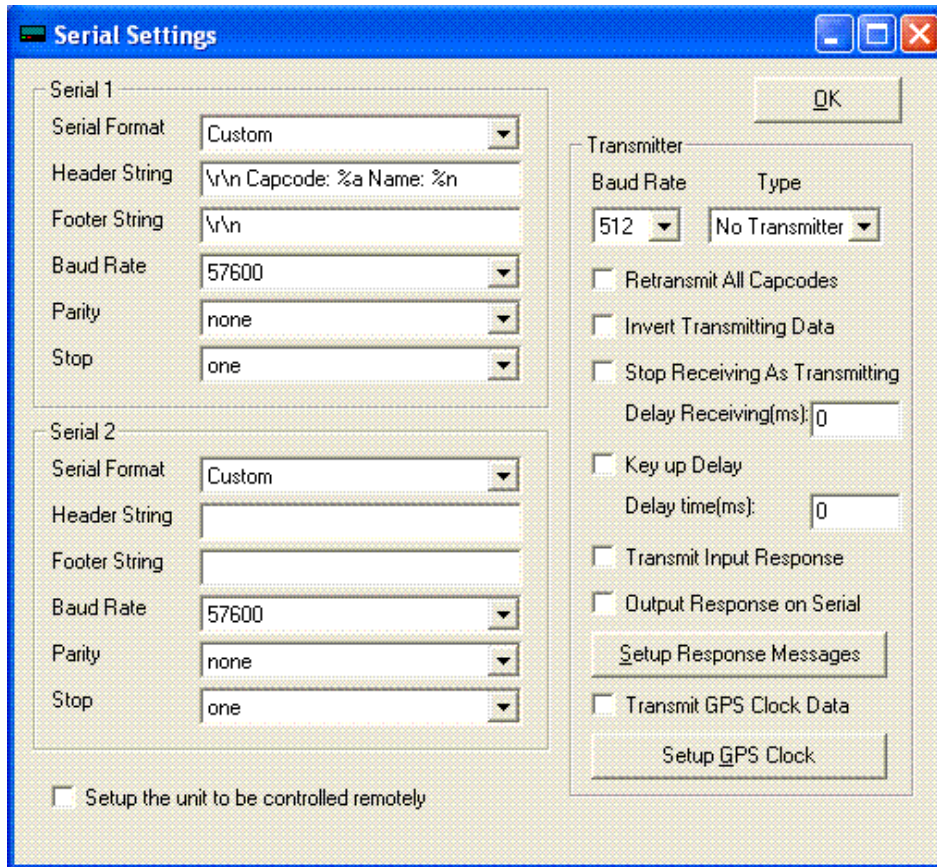

Serial

Set up serial output or input options

Serial Format

Contains a number of standard settings for serial options to commonly used equipment and software applications. For some serial formats, such as: "Control Input", "GPS Input", "IPage Input", "TNPP Output", "TNPP Input", "Output to Relay Board", "Message Direct to Relay Board" and "Message Manager", it is default to input or output all data through the serial port.

Header String

Sets the header string at the beginning of the serial output mainly for the "Custom" format.

Footer String

Sets the footer string at the end of the serial output mainly for the "Custom" format.

Some standard settings for header and footer strings are:

`\r\n ----- new line`

%n or %N ----- name of address

%a ----- address in decimal

%c ----- address in 7-digit decimal(If address is larger than 7-digit, it will be cut to 7-digit. If it is less than 7 digits, zero will be padded)

%A ----- address in hexadecimal

%p ----- protocol

%m ----- message type

%b ----- baud rate in 4-digit decimal, i.e. 0512

%B ----- baud rate in hexadecimal

%l ----- numeric level, i.e. 0-3

%L ----- alpha level, i.e. A-D

%t ----- 24 hour with second

%T ----- 24 hour time

%s ----- 12 hour with second

%h ----- 12 hour time

%d ----- day

%M ----- month

%y ----- year

%Y ----- day/month/year

%U ----- month/day/year

%I ----- year/month/day

For example: \r\n Name:%n Capcode:%a Protocol:%p Time:%T Date:%Y \r\n

Transmitter

Select and set up a transmitter

Type

Salcom 11-72 transmitter connected to the serial port one

Tait 800 connected to the DB25 port(TTL)

Maxon SD-125 radio connected to the DB25 port(TTL)

Apollo TX-125 transceiver connected to the DB25 port(TTL)

Retransmit all capcodes

Output all capcodes and messages to the transmitter

Invert Transmitting Data

Output inverted bit stream data to the transmitter

Stop receiving during retransmitting

The receiver will stop receiving while it is transmitting. This must be set if retransmitting on the same frequency.

Delay receiving

The receiver will be delayed to restart while the transmitting is finished. This should be used if retransmitting on the same frequency.

Key up Delay

The unit will hold data for a period of time(ms) before transmitting it. This will stop receiving as well before and after transmitting if set above "Stop receiving during retransmitting"

Transmit Input Response

Transmit data from serial control input or logical level input pins (DB25 TTL) on the selected transmitter.

Output Response on Serial

Output the data from serial control inputs and logical level input pins to the other serial port when one serial format is "Control Input" and the other serial format is "Control Output", or "TNPP Output", or "Custom", or "RC8660 TTS"

Setup Response Messages

Set messages for serial control inputs and logical level input pins

Response Input Options Window

This window is used to set the messages and transmit them with the specific capcodes.

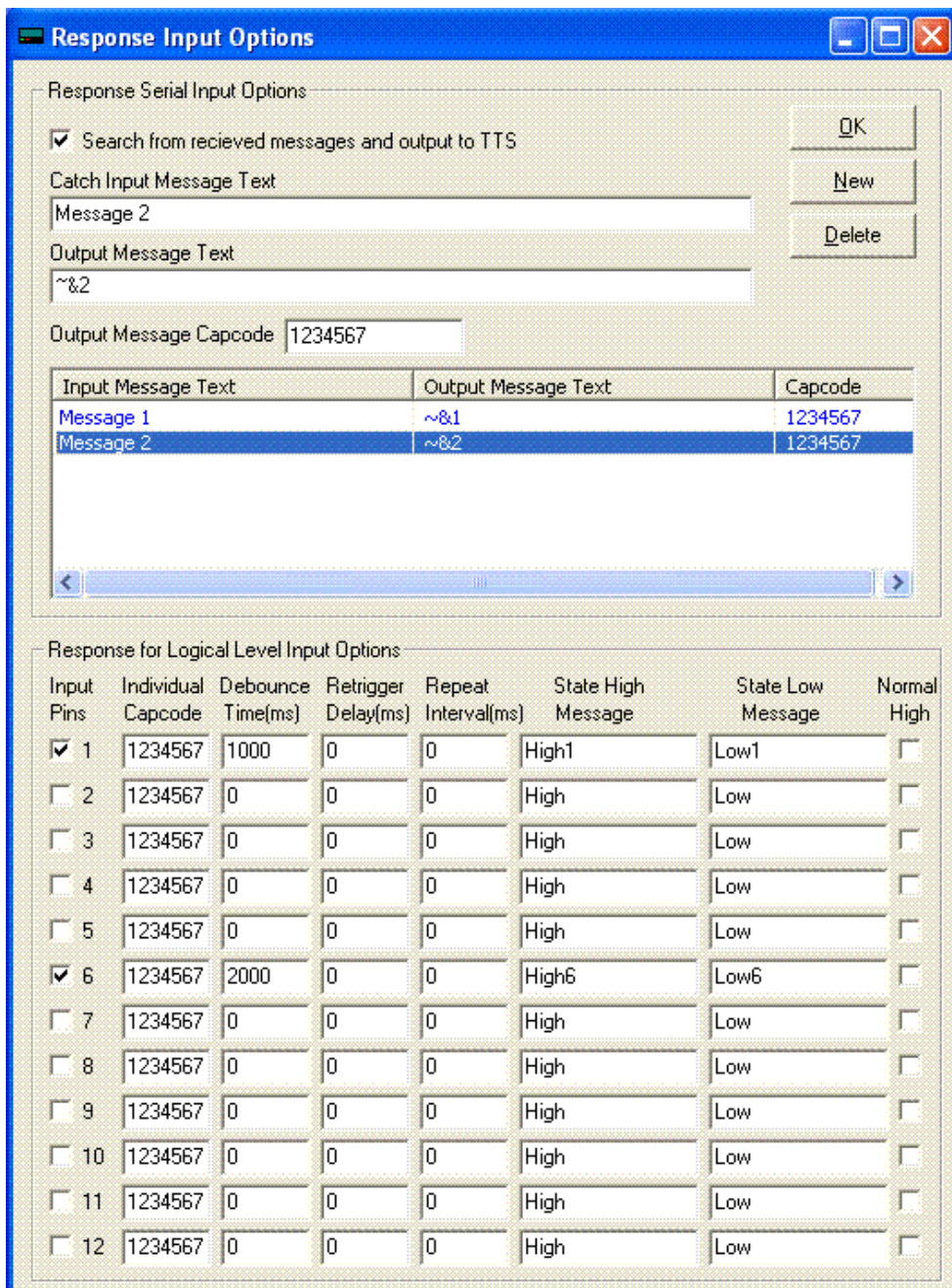

Search messages from the receiver and output to TTS:

Tick this, will search from received messages from the receiver and will output the replaced messages to TTS if having any matched message. This function only applies when the serial two format is "RC8660 TTS".

Response Serial Input Options:

Set the input messages which correspond to the output messages with the specific capcodes. A finished sign for input messages should be a line feed, or a carry return.

If the "Catch Input Message Text" is '*' and the "Output Message Text" is '*', this function will output all input messages except the finished signs.

Response for Logical Level Input Options:

Set output messages for input pin states. The messages will be transmitted or output on serial when the input pin state changes.

Input Pins: set pins whose states will be monitored.

Capcode: a different capcode can be assigned per input.

Debounce Time: time that contact must be triggered for before the alarm signal is generated.

Retrigger Delay: a period during which a new alarm will not be triggered again after the first trigger if multiple triggers occur. This only applies to non normal alarm trigger. Zero will disable this function.

Repeat Interval: this is the time interval after which if the state of contact has not reverted to its normal state then the message will be retransmitted and will continue to be retransmitted on this interval until the alarm reverts to normal. This only applies to non normal alarm trigger. Zero will disable this function.

State High Message: a message will be transmitted or output on the serial when the pin state high occurs. If no message is entered then no alarm transmission will occur on the change to high state.

State Low Message: a message will be transmitted or output on the serial when the pin state low occurs. If no message is entered then no alarm transmission will occur on the change to low state.

Normal High: Set normal or start pin state as high. If not selected then the normal state is low.

Message Relay Options Window

This window is used to set global relay control actions according to the text contained in a message received on the selected capcodes. Up to 256 actions may be set for each cap code from version 7 or over. Sets the action that will occur on each of the 4 on board relays and the relays contained on the RCM2000 module (if connected) on receipt of matched text in the message on a specified capcode.

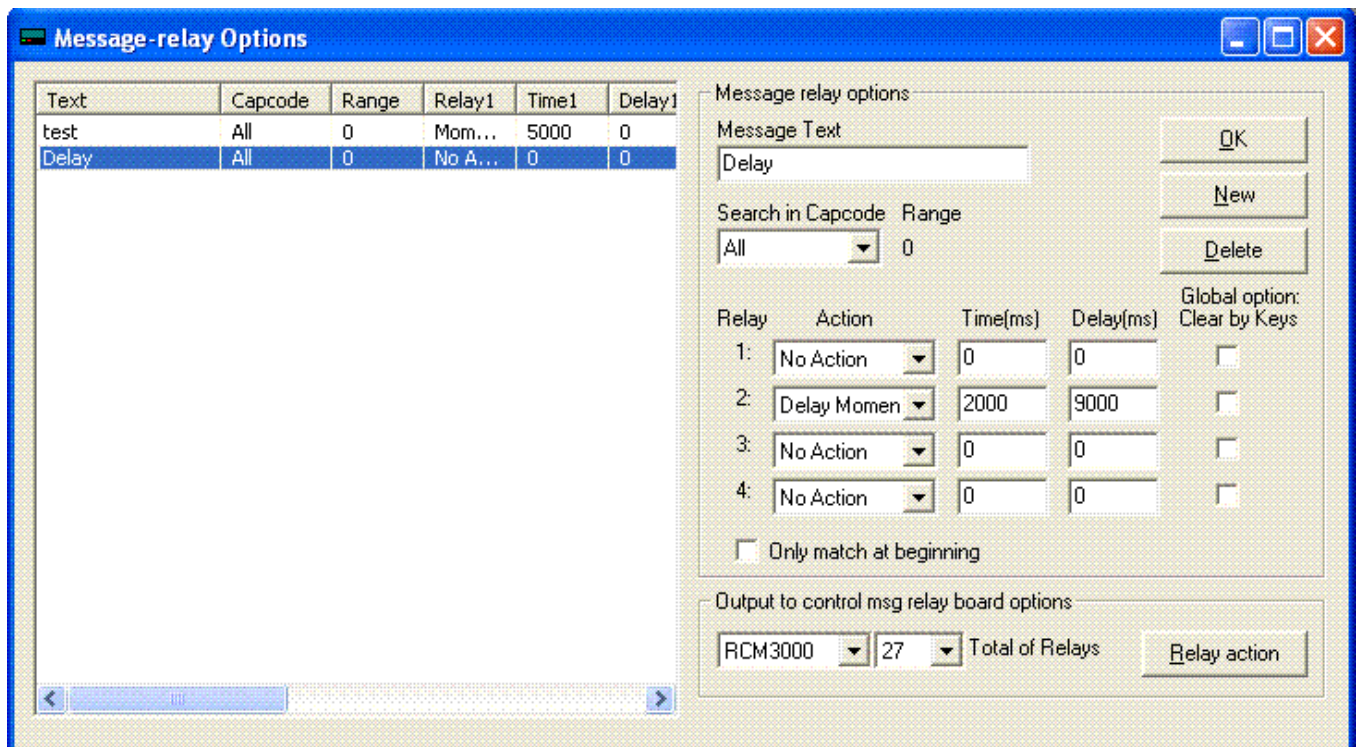

Adding Text to Control Relays

1. Click on the "New" Button to create a list in the message relay options table.
2. Enter the new text to be matched in the specified message in the "Message Text" box.
3. Select the specified capcode whose messages will be searched to match the text in the "Message Text" box.
4. Set the action that will occur on each of the four on board relay and the relays contained on the RCM2000 relay board.

Control Relay Options

Relays 1-4

Sets the action that will occur on each of the 4 on board relays on receipt of any message on that capcode. Relays are Normally Open. Options are

1. Close Relay
2. Open Relay
3. Momentary Close Relay for a period (in msec)
4. Delay Momentary Close: delay in msec then momentary close in msec
5. Clear by Keys - resets the relay to open on pressing any key.

Global Option Clear By Keys

If selected any relay action initiated by any Message Text will be cancelled (reset to normal condition) by hitting any key (PDT2000 only).

Only match at beginning

If selected only text at the beginning of the message will be matched with the target text

Output to Control Relay Board Options

This sets the actions of any one or more of the relays contained on the RCM2000 module. Each RCM2000 adds 32 additional relays and may be daisy chained. (Note: The RCM2000 connects to a serial port and the serial output format must be set to "Output to Relay Board").

Select the "Total of Relays" which is determined by the number of chained RCM2000 modules connected (x32).

Click the "Select relay action" Button to start up the Message Control Relay Board Options Window.

Message Control Relay Board Options Window

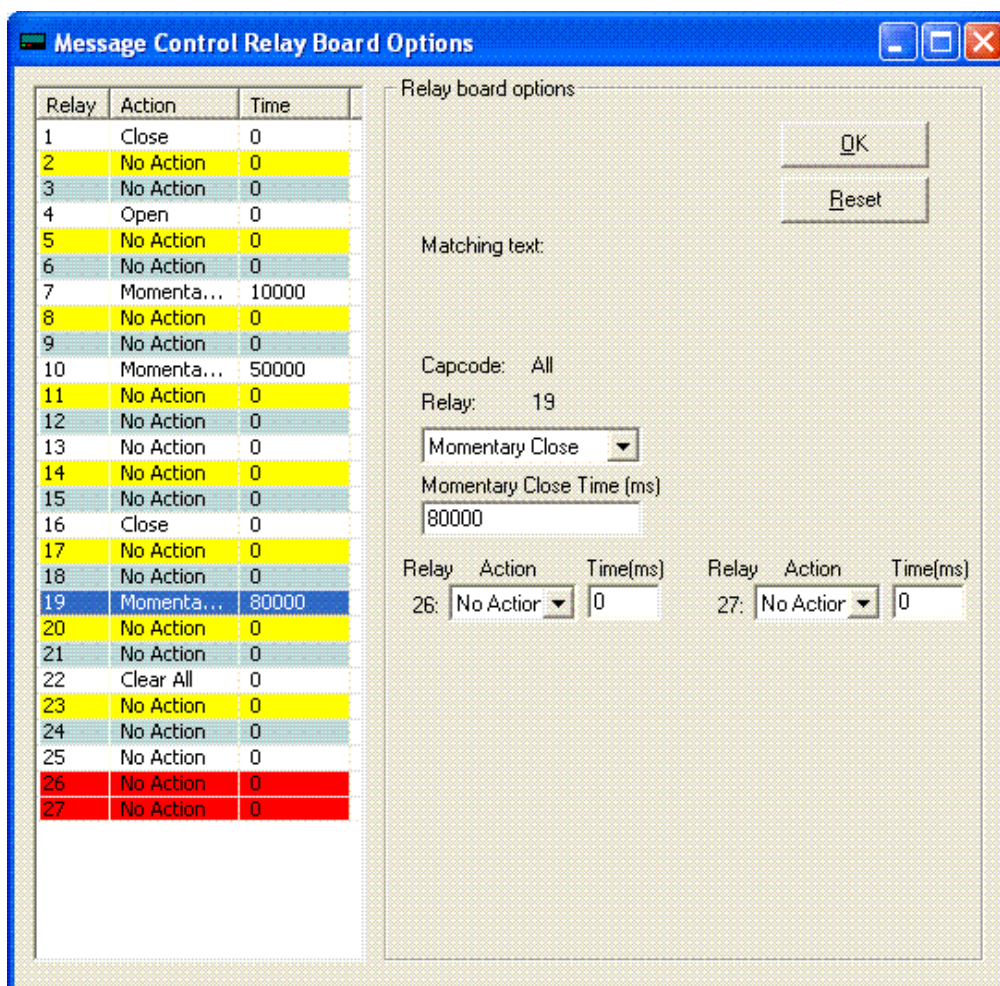

Click any number of relays at the relay list table in this Window, then select the action in the "Relay Action" and "Momentary Close Time" box. After finishing all settings, click the "OK" Button to save the settings and return to the last window.

Click the "Reset" button to clear the relay list table and give up the current settings.

[The Alert Options Window \(PDR/PSR Only\)](#)

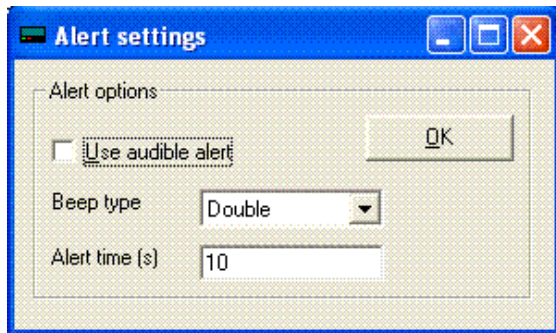

This window appears only in PDR/PSR templates. (Alerts are set in the PDT via the PDT user interface).

It is used to turn audible alerting on and off and set the type and length of the audible beep.

[The Frequency & Notes Window](#)

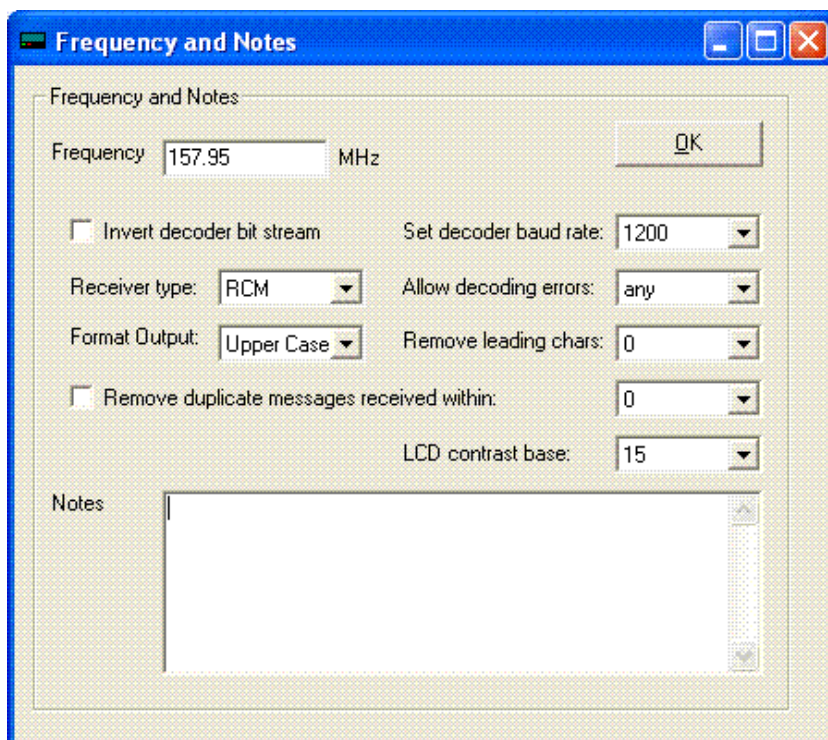

[Frequency](#)

Set the synthesized frequency. Note: the frequency must be within the frequency band of the receiver supplied. This will normally be noted in the Notes section.

[Invert Decoder Bit Steam](#)

Use this if your pager is set to data inverted. Consult your carrier before using this option.

[Set Decoder Baud Rate \(POCSAG ONLY\)](#)

Use to set the baud rate (pocsag only). This may be set to auto although better performance may be

experienced if all pagers are on one baud rate and the unit is set to that baud rate.

Flex Network Options (Flex ONLY)

The options are only related to Flex network:

1. None: no action.
2. Set Time: Allow Flex Paging Network to set the unit time by air.
3. Output CTAP: Output temporary addresses(CTAP).
4. Time&CTAP: Allow Flex Paging Network to set the unit time by air and Output temporary addresses(CTAP).
5. Output Code: Output temporary addresses with the counting code number(replace the original message).
6. Time&Code: Allow Flex Paging Network to set the unit time by air and Output temporary addresses with the counting code number.

Receiver type

Please consult with WiPath before using this option. A RCM receiver is being progressively introduced from Q3 2005. On the PDT2000 an RSSI (Received Signal Strength Indicator) will appear on the display when the RCM receiver is in use.

Allow decoding errors

Selects the number of character errors that the receiver will accept before it discards (ignores) the message.

Format Output

1. None: no action.
2. Remove Ctrl Chara: remove some control(unreadable) characters in a message before it outputs the message.
3. Upper Case: output all messages as upper case.
4. Both: remove control(unreadable) characters from the messages and output as upper case.
5. RSSI Tag: attach RSSI(Receiver Signal Strength Indicating) data at the end of messages.
6. Remove&Tag: remove some control(unreadable) characters in the message and attach RSSI data at the end of the message.
7. Upper Case&Tag: output all messages as upper case and add RSSI data tag at the end of the message.
8. All: all three options.

Remove leading characters

Removes the selected number of leading characters in a message before it outputs the message or applies any message filters. This is used to ignore special characters used by some systems for special decoding options.

LCD contrast base

This option is only for the PDT. It sets the base contrast value for the LCD display. Recommended: 0 for the green screen and 15~30 for the blue screen.

Remove duplicated messages

This option will ignore the duplicated messages for the period which you select.

Notes

An area to make general notes on this unit. This information is stored on the PDT/PDR so that it can be read whenever the unit is programmed.

OTAP Options Window

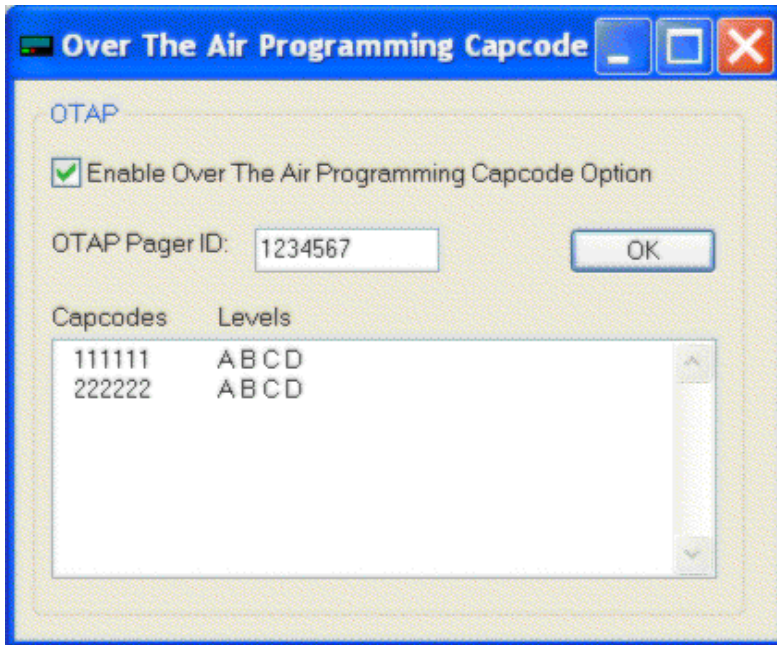

Over The Air Programming capcode options give the PDT/PDR/PSR ability to add or to delete capcodes for receive and display only (consider other settings e.g. print, relay etc).

Enable Over The Air Programming Capcode Option

Set the PDT/PDR/PSR to have Over The Air Programming capcode function which can add or delete capcodes. This function can decrypt OTAP messages which are created by the "OTAP Encryption" program in the PDT3P folder.

OTAP Pager ID

Set the PDT/PDR/PSR to have a unique 7-digit number id to decode the OTAP message. The pager only processes the OTAP message when it contains its id or broadcast id or its group id. The 1200000 is broadcast id which can program all units. The first 3-digit following by 5 zero is a group id which can program all starting with that 3 digits. For example: 1230000 would program all starting with 123 and following any 5 digits like 1234567.

Capcodes Levels

This window is for display OTAP capcode and levels ONLY(can not edit the contents in this window) after operating "Get OTAP Capcode" from ES tool bar

The PDT UI Settings Window

This window will appear in the PDT2000 templates only. It is used to set standard User Interface settings that are normally set by the user via the PDT2000 display.

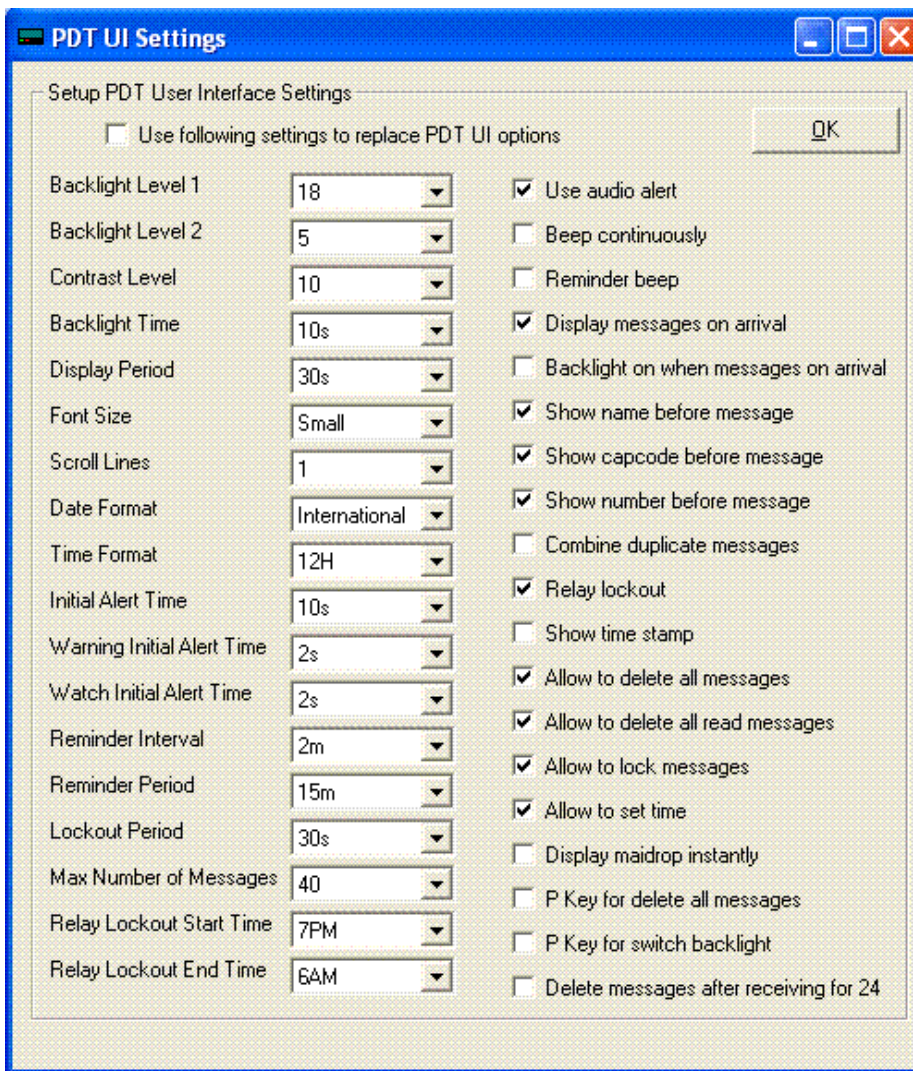

Use the following settings

If this box is checked the settings will be settable only from PDT3P and not from the PDT2000 user interface. (Except Backlight and contrast levels and the date and time).

Settings

Function	Description	Settings
Backlight Level 1	Sets the initial display backlight level 1	1-20
Backlight Level 2	Sets the initial display backlight level 2	1-20
Contrast Level	Sets the initial display contrast level	1-20
Backlight Time	Set how long backlight is to remain on after key press	5s/10s/30s/1m/5m/Permanent
Display Period	Set the amount of time the message will display for before reverting to main screen.	5s/10s/30s/1m/5m/Permanent
Font Size	Sets the size of the message font on the display. Small, medium, large	
Scroll Lines	Sets the number of lines to scroll when the down button is pushed when a message is displayed.	1,3
Date Format	Display dates mm/dd/yy or dd/mm/yy	US or International
Time Format	12 or 24 hour	12 or 24

Initial Alert Time	How long beeper sounds on initial receipt of message	1s/5s/10s/30s/1m/ 5m
Warning Initial Alert Time	How long beeper sounds on initial receipt of a message on a Warning capcode.	0,1s,2s,3s,4s,5s,10s,30s,60s,300s
Watch Initial Alert Time	How long beeper sounds on initial receipt of a message on a Watch capcode.	0,1s,2s,3s,4s,5s,10s,30s,60s,300s
Reminder Interval	How often the reminder beep sounds - every	30s/1m/2m/3m/4m/5m
Reminder Period	How long reminder beep continues for	5m/10m/15m/30m/Forever
Lockout period	The period during which no additional activation of relays shall occur given the same activation instruction.	0,1s,2s,3s,5s,10s,20s,30s,1m,2m,3m,5m,10m,20m,30m
Max Number of Messages	The Max number of messages can be displayed on PDT screen.	1,2,3,5,10,15,20,25,30,35,40
Relay Lockout Start Time	The time to start locking out the relay actions	0,1,2,3,4,5,6,7,8,9,10,11,12,13,14,15,16,17,18,19,20,21,22,23
Relay Lockout End Time	The time to end locking out the relay actions	0,1,2,3,4,5,6,7,8,9,10,11,12,13,14,15,16,17,18,19,20,21,22,23
Audible Alert	Beeper sounds on receipt of message	On or Off
Beep Continuously	Beeper sounds until message is acknowledged by pressing any key	On or Off
Reminder Beep	Reminder beep sounds until message is read	On or Off
Display Messages on Arrival	Display message automatically when received	On or Off
Backlight On When Messages Arrive	Turn the backlight on on receipt of a message	On or Off
Show [Name] Before Message	Display the name assigned to the cap code/address at the beginning of the message (set via PDT3P)	On or Off
Show [Capcode] Before Message	Display Capcode at the beginning of the message.	On or Off
Show [Number] Before Message	Display the slot number of the message at the beginning of the message (1-40)	On or Off
Combine Duplicate Messages	If set to on & a message identical to a previous message is received it will not be displayed as a separate message	On or Off
Display Lines	Set no of lines of text on display - Changes Text size	On or Off
Relay Lockout	Turns the relay lockout function on or off - See Lockout period above	On or Off
Show Timestamp	Place the date and time of receipt at end of message	On or Off
Allow to delete all messages	Turns the delete all function on	On or Off

Allow to delete all Read messages	Turns the delete all read messages function on.	On or Off
Allow to lock messages	Allows user to lock messages	On or Off
Allow to set time	Allows user to set time	On or Off
Display maildrop instantly	Displays maildrop messages instantly	On or Off
P key to delete all messages	Changes P key from print to purge all - same as Delete All	On or Off
P key to switch backlight levels	Changes P key from print to switch two backlight levels	On or Off

[PDT3000 Peripherals](#)

This part describes how to connect a PDT3000 (or PDR/PSR) to supported peripherals.

[Port Pin-out](#)

The usable ports on the PDT3000 are as follows:

DB25: parallel/printer output.

DB9: PC/serial output 1, and various other peripherals.

RJ11: PC/serial output 2.

RJ45: These two ports have 4 relays (2 each), they are wired for normally open, and normally closed outputs.

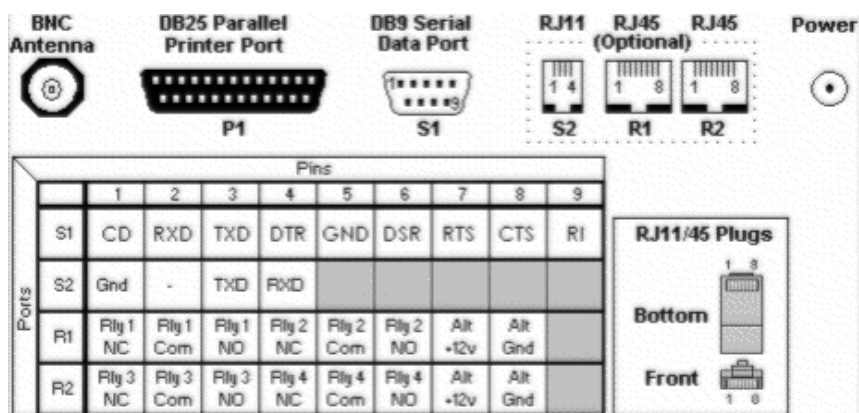

[Serial Port2 to PC Cable](#)

Serial output 2 RJ11 to PC DB9 cable



PC DB9 Female



PDT J3 RJ11

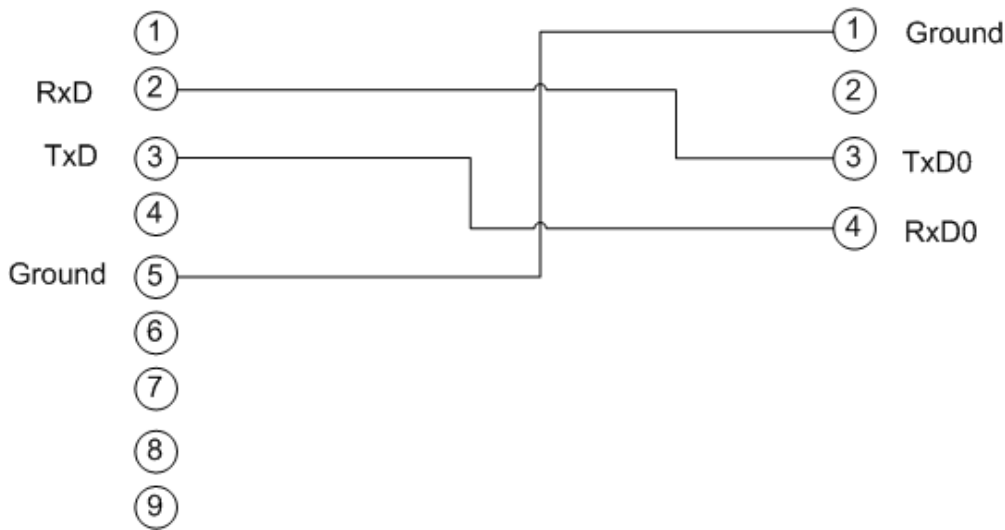

[Salcom 11-72](#)

The Salcom 11-72 (or 11-78) is a NRZ FM transmitter used for pocsag paging. It can be set up from the "Serial Settings" window in the PDT3P by selecting transmitter type as "Salcom 11-72". It is connected on the PDT2000 serial output 1 (DB9).

11-72 connector(s)

DB15 pin 13 - data input 1, plug into PDT3000 DB9 pin 4 (DTR)

DB15 pin 5 - PTT, plug into PDT3000 DB9 pin 7 (RTS)

DB15 pin 1 - GND, plug into PDT3000 DB9 pin 5 (GND)

[Salcom 11-62](#)

The Salcom 11-62 is a pocsag encoder and transmitter. For new users the 11-72 is recommended as it is significantly less expensive, and the functionality (for PDT2000 users) is identical. It can be set up when by selecting "Salcom Encoder" as the serial output format and the 11-62 is connected to the serial 1 (DB9).

DB9 - DB9, via a straight through cable.

Pin 2 - pin 2

Pin 3 - pin 3

Pin 5 - pin 5

All other pins not used.

[Tait T800](#)

The Tait T800 is a larger NRZ FM transmitter used for pocsag paging. It is connected to the PDT2000 DB25 and is set up by selecting transmitter type as "Tait T800" on the "Serial Settings" window.

PDT3000 DB25 pin 1 data out

PDT3000 DB25 pin 16 PTT

PDT3000 DB25 pin 18-25 Ground

Maxon SD-125

The Maxon SD-125 is a NRZ FM transmitter used for pocsag paging. This device is connected with PDT2000 DB25 (parallel port) and can be set up by selecting transmitter type as "Maxon SD-125" in the "Serial Settings" window.

PDT3000 DB25 SD-125 DB9

Pin1(Tx)..... pin1 or pin9(Tx)

Pin16(PTT) pin3(PTT)

Pin15(CD) pin6(CD)

Pin25(G) pin4(G)

Power pin5(+12V)

Apollo TX-125

The Apollo TX-125 is a NRZ FM transmitter used for pocsag paging. This device is connected with PDT2000 DB25 and can be set up by selecting transmitter type as "TX-125" on the "Serial Settings" window. Printer type must not be "parallel" in Printer settings of PDT3P.

PDT/PDR DB25 to TX-125 DB9

(DB25 Male)----- (DB9 Male)

Pin1(Tx) ----- pin7(Digital Mod In)

Pin16(PTT) ----- pin1(PTT)

Pin15(CD) ----- pin6(CD)

Pin25(G) ----- pin5(Grd)

TXF-2000U

The Apollo TX-125 is a low powered NRZ FM transmitter used for pocsag paging. This device is connected with PDT2000 DB25 and can be set up by selecting transmitter type as "TXF-2000U" on the "Serial Settings" window. Printer type must not be "parallel" in Printer settings of PDT3P.

PDT/PDR DB25 to TXF-2000U Connector

(DB25 Male) ----- (4-Pin Connector)

Pin1(Tx) ----- pin1(Data)

Pin16(PTT) ----- pin4(PTT)

Pin25(G) ----- pin2(Grd)

Power 9~12V ----- pin3(VCC)

PSR3000 with Transmitters

The configuration for PSR to connect with transmitters(PSR3000 schematic V605 and PDTP4.3)

PSR3000 J2 ----- Transmitters

Pin1(Ground) ----- Ground
Pin5(OUT1) ----- PTT
Pin7(OUT2) ----- Tx data
Pin4(IO3) ----- Channel Detect(ONLY for Maxon SD-125)

Notes:

1. Pull-up resistors(3k~10k) must be connected for PTT and Tx data pins(by request: from 5V pin2 to pin5 PTT and to pin7 Tx data).
2. A pull-down resistor must be connected for Maxon SD-125 CD pin(from pin4 IO3 CD to pin1 ground)
3. When PSR uses transmitters, it can not use relays
4. Old ROM(version number is below 4.3) used different PTT, Tx data and CD pins. The PTT was on OUT3(p4d6), Tx data was on p4d7 and CD was on IO1(p5d1)

Alarm Inputs

The parallel port (DB25) may be used for monitoring alarm inputs, use the following configuration.

PDT3000 DB25 ----- Input Pins in PDT3P

Pin25(Ground) ----- Signal Ground

Pin2(Input1) ----- Logic Input 1

Pin3(Input2) ----- Logic Input 2

Pin4(Input3) ----- Logic Input 3

Pin5(Input4) ----- Logic Input 4

Pin6(Input5) ----- Logic Input 5

Pin7(Input6) ----- Logic Input 6

Pin8(Input7) ----- Logic Input 7

Pin9(Input8) ----- Logic Input 8

Pin10(Input9) ----- Logic Input 9

Pin11(Input10) ----- Logic Input 10

Pin12(Input11) ----- Logic Input 11

Pin13(Input12) ----- Logic Input 12

Pin14(VCC) ----- 5VDC supply (needs to be factory set)

PSR may be used for monitoring alarm inputs, use the following configuration(for PSR3000 schematic V605 and PDTP4.3).

PSR3000 J2 ----- Input Pins in PDT3P

Pin1(Ground) ----- Signal Ground

Pin8(IO1) ----- Logic Input 1

Pin6(IO2) ----- Logic Input 2

The signal is considered high when it is above +3.15v, and low when it's below +1.35v. For detailed specification on the tolerance of the input please look up the MC74HC245A converter IC manual. PDT/PDR DB25 Pins 10 to 13 have pulldown resistors fitted as standard, the remainder need to have pulldown resistors added (by request) if the unit is to

be used for alarm monitoring. PSR J2 IO1 and IO2 do not have pulldown resistors, the remainder need to have pulldown resistors added (by request).

PDT/PDR/PSR ROM Limitation

In the pdtV7.0.rom, the limitations are:

Max message length: 1024

Max number of Flex CTAP cap code: 1

Max number of matched cap codes for message relay: 256

In the pdrV3.8.rom, the limitations are:

Max message length: 1024

Max number of Flex CTAP cap code: 64

Max number of matched cap codes for message relay: 256

In the psrV3.8.rom, the limitations are:

Max message length: 1024

Max number of Flex CTAP cap code: 64

Max number of matched cap codes for message relay: 256

The psrVx.x.rom is for PSR ONLY. PDT can only use pdtVx.x.rom and PDR can only use pdrVx.x.rom.